



*Automatic Passenger Counting Sensor*

# IRMA 6

Interface: Switch

## Product Data Sheet

**Language:** en

**Document version:** 2.1

**Status:** Released

**Release date:** 01/2021

# Contents

<b>1</b>	<b>About this document</b> .....	<b>3</b>	<b>6</b>	<b>Communication Protocols and Standards</b> .....	<b>19</b>
1.1	Product .....	3	<b>7</b>	<b>Dimensions</b> .....	<b>20</b>
1.2	Function .....	3	<b>8</b>	<b>Spare Parts</b> .....	<b>23</b>
1.3	Symbols used in this document .....	4	8.1	IRMA6-SENSOR-HD-00-SWITCH-IO-00 (5300_04).....	23
1.4	Disclaimer.....	4	8.2	IRMA6-SENSOR-HD-00-SWITCH-00 (5300_05).....	23
1.5	Contact.....	4	8.3	IRMA6-SENSOR-HD-00-SWITCH-IO-00-R (5300_10).....	24
<b>2</b>	<b>Components</b> .....	<b>5</b>	8.4	IRMA6-SENSOR-HD-00-SWITCH-00-R (5500_11).....	24
2.1	Key Figures in brief.....	5			
2.2	Interface Units .....	7			
2.3	Sensor Unit.....	8			
<b>3</b>	<b>Connections</b> .....	<b>9</b>			
<b>4</b>	<b>Technical Data</b> .....	<b>10</b>			
4.1	General.....	10			
4.2	Power Supply .....	12			
4.3	Integrated Ethernet Switch .....	12			
4.4	Door Signal Input.....	13			
<b>5</b>	<b>Norms and Standards</b> .....	<b>14</b>			
5.1	EMC .....	14			
5.2	Climatic and Mechanical Tests .....	15			
5.3	Insulation Test.....	17			
5.4	Test of Protection Class .....	17			
5.5	Eye Safety .....	18			
5.6	Fire Protection Behavior .....	18			

# 1 About this document











## 1.1 Product

Product	Variant
IRMA 6	IRMA6-SENSOR-HD-00-SWITCH-IO-00-R
	IRMA6-SENSOR-HD-00-SWITCH-00

## 1.2 Function

Automatic passenger-counting sensor with 76,800 px Time-of-Flight-technology (ToF) for vehicle and railway application. Consisting of a sensor unit and an interface unit, mounted above vehicle door-entries. Generates real-time counting data for further processing via Ethernet to on-board computers.

## 1.3 Symbols used in this document

	Important		Recommendation
	Caution		Additional information
	See attachment		Reference
	Configure		Note down
	Contact		Website resource

## 1.4 Disclaimer

The information contained in this document is based on product data resulting from the development and approval phases as well as the production of initial samples. These specifications do not claim to be error-free and will need to be updated or corrected. Such modifications may be made by iris-GmbH without notice. Characteristic or typical values given are based on our experience and are approximate values to be expected; they are by no means guaranteed by iris-GmbH.

## 1.5 Contact

iris-GmbH infrared & intelligent sensors  
Schnellerstr. 1–5  
12439 Berlin  
Germany

Phone: +49 (0) 30 5858 14-0

E-mail: [service@iris-sensing.com](mailto:service@iris-sensing.com)

## 2 Components

### 2.1 Key Figures in brief

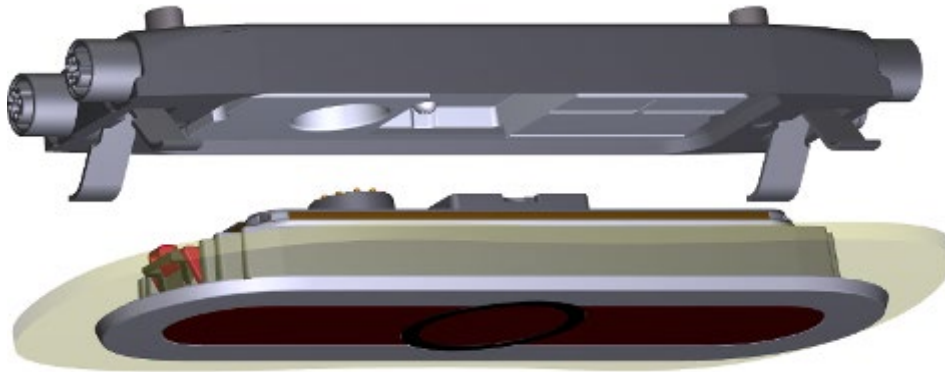

Figure 1: View - sensor and sensor unit

Item no.	Sensor type	Outlet 1	Outlet 2	Outlet 3	Outlet 4
5300_04	IRMA6-SENSOR-HD-00-SWITCH-IO-00	Power supply, (m), M12, a-coded, 5 pin	Door contact/ DoorClear, (f), M12, b-coded, 5 pin	Ethernet, (f), M12, d-coded, 4 pin	Ethernet, (f), M12, d-coded, 4 pin
5300_10	IRMA6-SENSOR-HD-00-SWITCH-IO-00-R				

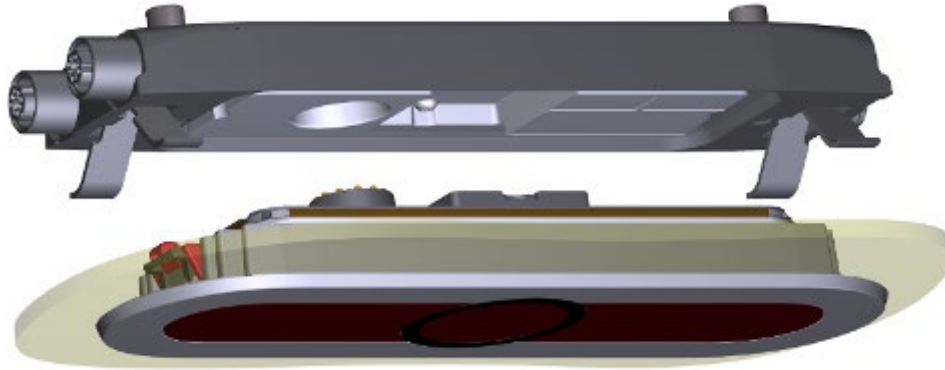

Figure 2: View - sensor and sensor unit

Item no.	Sensor type	Outlet 1	Outlet 2	Outlet 3	Outlet 4
5300_05	IRMA6-SENSOR-HD-00-SWITCH-00	Power supply, (m), M12, a-coded, 5 pin	N/A	Ethernet, (f), M12, d- coded, 4 pin	Ethernet, (f), M12, d- coded, 4 pin
5500_11	IRMA6-SENSOR-HD-00-SWITCH-00-R				

## 2.2 Interface Units

Sensor type	Connectors	Illustration	Connectors
IRMA6-SENSOR-HD-00-SWITCH-IO-00	Ethernet interface		Power supply
IRMA6-SENSOR-HD-00-SWITCH-IO-00-R	Ethernet interface		Door Clear/ Door contact
IRMA6-SENSOR-HD-00-SWITCH-00	Ethernet interface		Power supply
IRMA6-SENSOR-HD-00-SWITCH-00-R	Ethernet interface		N/A

## 2.3 Sensor Unit



Figure 3: Sensor front view (IRMA 6)



Figure 4: Sensor back view (IRMA 6)

### Field of view

Installation height [mm]	Maximal covered door width [mm]
1800	1250
1900	1400
2000	1550
2100	1700
2200	1850
2300	2000
2400	2150
2500	2300

The above values are standard values. In most cases wider ranges can be covered. For further support, please consult [service@iris-sensing.com](mailto:service@iris-sensing.com)



### 3 Connections

The following table lists the pin assignments of the interface unit.

2x M12 Ethernet (female, d-coded)

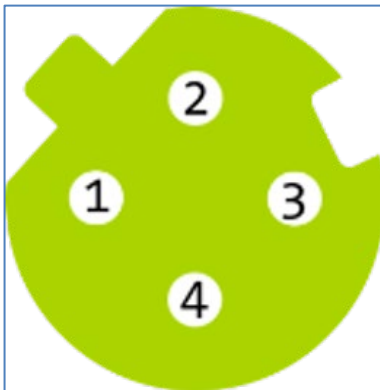

M12 GPIO (female, b-coded, 5 pin)

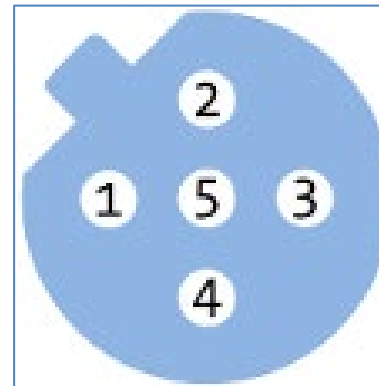

M12 power supply, typ. 24 V (male, a-coded, 5 pin)



Pin	Signal	Pin	Signal	Pin	Signal
Pin 1	TD+	Pin 1	Door signal +	Pin 1:	not connected
Pin 2	RD+	Pin 2	Door signal -	Pin 2:	VCC
Pin 3	TD-	Pin 3	Door clear +	Pin 3:	GND
Pin 4	RD-	Pin 4	Door clear -	Pin 4:	not connected
		Pin 5	Not connected	Pin 5:	not connected

## 4 Technical Data

### 4.1 General

#### Operating conditions

Parameter	Min	Max	Note
Operating temperature range (TB)	-25 °C -13 °F	+55 °C +131 °F	According to EN 50155:2017
Mean Time Between Failures (MTBF)		1.25 x 10 <sup>6</sup> h	Condition: 25 °C / 77 °F

#### Transport and storage

Parameter	Min	Max	Note
Temperature range (TL)	-40 °C -40 °F	85 °C 185 °F	According to EN 50155:2017

#### General information

Parameter	Min	Max	Note
Weight sensor unit		279 g ±2 %	
Weight interface unit		228 g ±2 %	
Weight total		507 g ±2 %	Sensor unit + interface unit

Parameter	Min	Max	Note
Weight interface unit (IO variant)		244 g ±2 %	
Weight total (IO variant)		523 g ±2 %	Sensor unit + interface unit (with IO-connector)
Resolution		320 x 240 px	
Dimensions over all		217 (L) x 62 (W) x 32.2 mm (H)	
Housing material			Aluminium die cast
Material of optical openings			Makrolon 2405, color 450601
Backcover		Xydar <sup>®</sup> G-930-LCP-GF30	Glass fibre reinforced plastic
Protection class of housing		IP65	According IEC 60529, when mounted
Field of view		69° x 52° (cross x lengthwise)	
Mounting height	1.80 m	2.40 m	Passengers need to be able to walk upright below the sensor.
Relative humidity		max. 95%	
IK protection class			IK5
Required scene illumination			None

Table 1: Technical sensor data

## 4.2 Power Supply

Parameter	Unit	Min	Max	Comments
Supply voltage DC*	$U_{Vp+}$ in V	+16	+60	External power supply; typical value: +24 V; +36 V
Power consumption*	$P_N$ in W		16	With vehicle door open and +24 V supply voltage, +25 °C (+77 °F) ambient temperature Typical value: 9 W
Power supply interface*	M12 a-coded, 5 pin male			

Table 2: Power supply

\* According to EN 50155:2017

## 4.3 Integrated Ethernet Switch

Parameter	Unit	min.	typ.	max.	Comments
Interface transmission rate Ethernet	in Mbit/s			100	
Ethernet interface	M12 d-coded, 4 pin female				
Switch ports	no unit			2	
Number of sensors that can be daisy chained	no unit	1		12	

Table 3: Integrated Ethernet switch

**Remarks:**

- It is preferable to avoid cluttering the sensor chain's bandwidth by introducing other devices that are not sensors.
- When building up a daisy chain of sensors the streaming of the sensor's 3d data is limited to one sensor at a time.

## 4.4 Door Signal Input

This section applies to following sensor variants:

- IRMA6-SENSOR-HD-00-SWITCH-IO-00, 5300\_04
- IRMA6-SENSOR-HD-00-SWITCH-IO-00-R, 5300\_10

Parameter	Min	Max	Note
<b>Input</b>			Bipolar (+/-)
Input level low	0 V	(+/-) 6 V	
Input level high	9 V	(+/-) 60 V	Protection limit at load 60 V
Switching frequency		50 Hz	
Insulation against I/O		60 V	
Current		140 mA	
Isolation against $V_{cc}$ and ground (housing)		2 kV	

Table 4: Door signal input

## 5 Norms and Standards

All data are design goals. Reports or certifications are available at serial launch.

### 5.1 EMC

#### Compliance with standards, device tests

Field	Standard, test standard	Comments
Noise radiation, immunity to interference	EN 50121-3-2:2017	Electromagnetic compatibility (railway application)
	EN 50155:2017 Pkt. 5.1.1.4, Cl. S2 Pkt. 5.1.3, Cl. C1	Immunity to variations of voltage supply/interruption of voltage supply (railway application)
	2014/30/EU	EMC directive, basis for CE marking
	EBA EMV:06 2014-06	EMC directive based of rules from the Federal Railway Authority (Germany). The Federal Railway Authority is the German supervisory, licensing and safety authority for railways and railway undertakings
Motor vehicle	ECE R 10:2017-02-17	<b>E1)</b> Regulation No 10 of the Economic Commission for Europe of the United Nations (UNECE) - Uniform provisions concerning the approval of vehicles with regard to electromagnetic compatibility Approval No.: under test

Table 5: Compliance with EMC standard

## 5.2 Climatic and Mechanical Tests

### Compliance with standards, device tests

Field	Standard, test standard	Railway application	Comments
Climatic standards	EN 50155:2017	EN 50155:2017	EN 50155:2017 – <i>Railway applications - Rolling stock - Electronic equipment</i> ; German translation: DIN EN 50155:2018-05 – <i>Bahnanwendungen - Elektronische Einrichtungen auf Schienenfahrzeugen</i>
	IEC 60068-2-1	OT1 (4) IEC 60068-2-1, -2-2: 2008	<b>Cold</b>
	EN 50155:2017	EN 50155:2017 item 13.4.4	Test Ad (function)
	EN 50155:2017	EN 50155:2017 item 12.2.14	Test Ab (storage)
	IEC 60068-2-2	IEC 60068-2-2	<b>Dry heat</b>
EN 50155:2017	EN 50155:2017 item 12.2.4	Test Be (function) and Test Bb (storage +85°C, 185°F)	

Table 6: Compliance with climatic standards

**Compliance with standards, device tests**

Field	Standard, test standard	Railway application	Comments
Mechanical standards	IEC 60068-2-6	IEC 60068-2-6: 2007	
	IEC 60068-2-64	IEC 60068-2-64, -2-27: 2008	
	IEC 60721-3-5	IEC 60721-3-5: 1997	
	EN 50155:2017	EN 50155:2017 item 12.2.11/	Vibration,
	IEC 61373	IEC 61373:2010 item 9, Cl. B, Cat. 1/	broad band noise,
	IEC 60068-2-64	IEC 60068-2-64	endurance test - Test Fh
	EN 50155:2017	EN 50155:2017 item 12.2.11/	Shock test - Test Ea
	IEC61373	IEC61373 item 10, Cl. B, Cat.1/	
	IEC 60068-2-27	IEC 60068-2-27	
	EN 50155:2017	EN 50155:2017 item 12.2.11 /	Vibration,
	IEC 61373	IEC 61373 item 8, Cl. B, Cat. 1/	broad band noise,
	IEC 60068-2-64	IEC 60068-2-64	functional test - Test Fh
	IEC 60721-3-5	IEC 60721-3-5 Tab. 6, Cl. 5M3/	Vibration, random - Test Fh
	IEC 60068-2-64	IEC 60068-2-64	
	IEC 60721-3-5	IEC 60721-3-5 Tab. 6, Cl. 5M3/	Vibration, sinusoidal –
	IEC 60068-2-6	IEC 60068-2-6	Test Fc
IEC 60721-3-5 IEC 60068-2-27	IEC 60721-3-5 Tab. 6, Cl. 5M3/ IEC 60068-2-27	Shock test - Test Ea (spectrum 1), (spectrum 2) without external shock loads	

*Table 7: Compliance with mechanical standards*



## 5.3 Insulation Test

### Compliance with standards, device tests

Field	Standard, test standard,	Railway application	Comments
Insulation test	EN 50155:2017	EN 50155:2017 item 12.2.9	

Table 8: Insulation test

## 5.4 Test of Protection Class

### Compliance with standards, device tests

Field	Standard, test standard	Railway application	Comments
Degrees of protection provided by enclosures	IEC 60529	IEC 60529: 1989 + A1: 1999 ++ A2:2013	
	IEC 60529	IEC 60529 §13.4	Shock hazard protection test
	IEC 60529	IEC 60529 §14.2.5	IP65 test

Table 9: Compliance with standards - protection class (IP)

## 5.5 Eye Safety

### Compliance with standards, device tests

Field	Standard, test standard	Railway application	Comments
Eye safety	EN 60825-1:2014	EN 60825-1:2014	Safety of laser products, class 1

Table 10: Compliance with standards - Eye safety

## 5.6 Fire Protection Behavior

### Compliance with standards, device tests

Field	Standard, test standard	Railway application	Comments
Fire protection on railway vehicles Conformity evaluation	DIN EN 45545-2:2016-02	DIN EN 45545-2:2016-02	Fire protection on railway vehicles Conformity evaluation

Table 11: Compliance with standards - Fire protection behaviour

## 6 Communication Protocols and Standards

The IRMA 6 sensor will be equipped with an Ethernet port (find further information in chapter: Interface Units , p. 7.).

**Communication protocols:** DHCP, HTTP(S), MQTT, SNMP, mDNS, DNS-SD, TCP/IP/UDP

### Application communication protocols:

- **QIP** (beta version available):

The QIP or Quick Integration Protocol is the default IRMA 6 communication protocol. It is a simple HTTP based protocol offering all needed operations to operate the sensor. It is recommended for any project where neither ITxPT nor IBIS-IP is specifically required. The data are exchanged in XML format and offer some level of compliance with ITxPT. It is also possible to configure the sensor to push its counting data via MQTT.

A specification can be found in the **Quick Integration Manual**.

- **ITxPT** (in development):

ITxPT is a European standard defining a service oriented IT architecture for public transportation. The IRMA 6 sensor implements the APC service and ModuleInventory service and may interact with other services in the vehicle such as the Time, FMSToIP, VehicleToIP or AVM services. Two profiles are available: the in-vehicle profile where communication happens via HTTP XML-formatted messages within the vehicle's IP network, and the over-the-air profile, where the counting data are pushed via MQTT.

Specifications can be found here: <https://itxpt.org/technology/itxpt-specifications/>

- **IBIS-IP** (in development):

IBIS-IP or VDV 301 provides an IP-based service oriented successor standard for the IBIS Wagenbus defined in VDV 300. The IRMA 6 sensor implements the Passenger Counting, Device Management and Door State services. The communication happens via HTTP XML-formatted messages. IBIS-IP is recommended for following areas: Germany, Austria and Switzerland.

Specifications can be found here: <https://www.vdv.de/ip-kom-oev.aspx>

- **UIP<sup>RETROFIT</sup>** (beta version available):

UIP<sup>RETROFIT</sup> is a minimal implementation of IRMA MATRIX's legacy protocol UIP, aimed at retrofit projects. All functionalities of UIP are implemented except the image

streaming and parameter/firmware update. The latter operations can be performed using the QI protocol (see above "QIP").

## 7 Dimensions

Dimensions outer part	4 mm (H) x 62 mm (W) x L: 192 mm (L)
Dimensions inner part	28.5 mm (H) x 52.82 mm (W) x 211 ±2 mm (L)
Dimensions inner part below door panel	28.5 mm (H) – x mm (door panel thickness)* x 52.82 mm (W) x 211 ±2 mm (L)

\* 'X' in graphic below

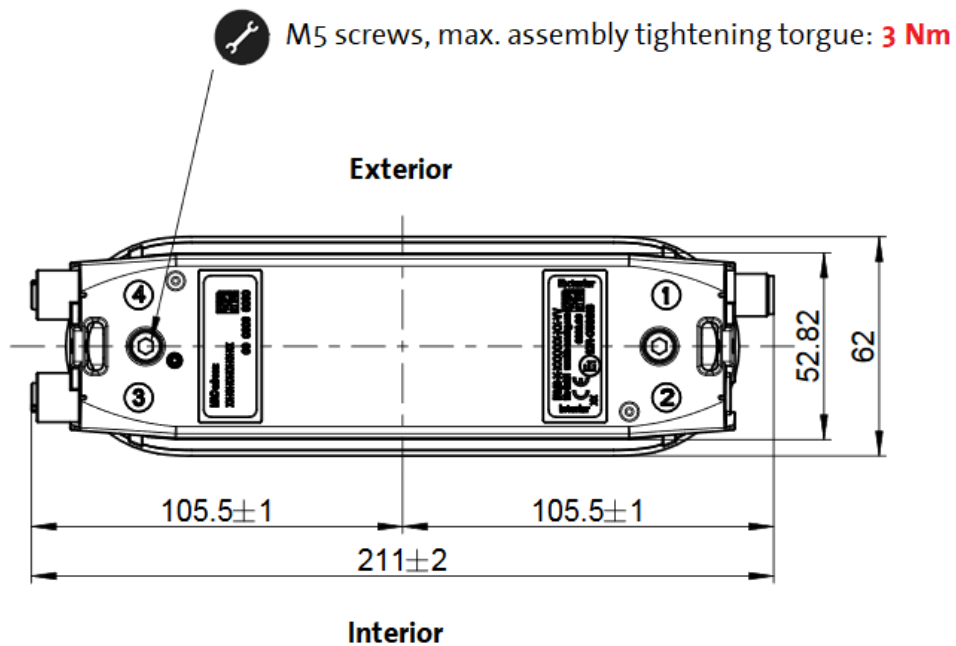

Figure 5: Dimensions – Bottom view IRMA6-SENSOR-HD-00-SWITCH-IO-00-R

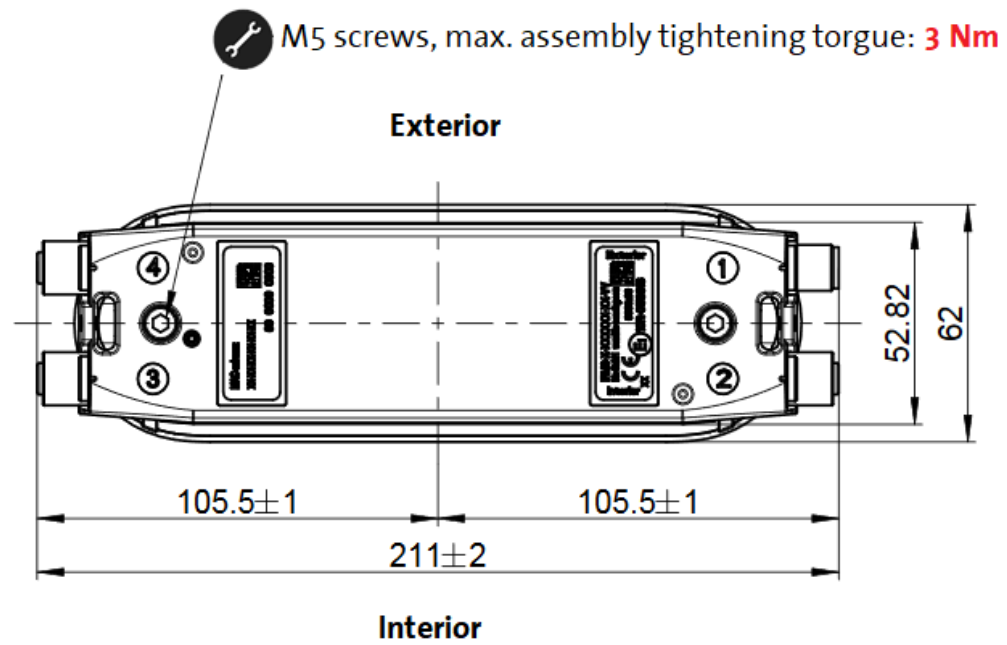

Figure 6: Dimensions – Bottom view IRMA6-SENSOR-HD-00-SWITCH-00

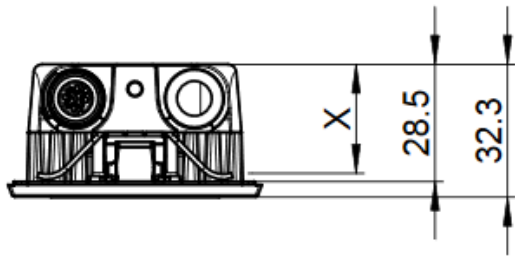

Figure 7: Dimensions – Side view (height)

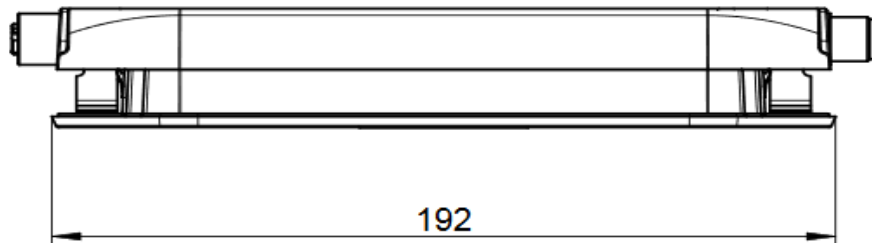

Figure 8: Dimensions (length)

## 8 Spare Parts

### 8.1 IRMA6-SENSOR-HD-00-SWITCH-IO-00 (5300\_04)

Item no.	Item name	Part
5400_00	IRM6-S-HD-00	Sensor unit
5500_04	IRM6-I-SWITCH-IO-00	Interface unit

### 8.2 IRMA6-SENSOR-HD-00-SWITCH-00 (5300\_05)

Item no.	Item name	Part
5400_00	IRM6-S-HD-00	Sensor unit
5500_05	IRM6-I-SWITCH-00	Interface unit

### 8.3 IRMA6-SENSOR-HD-00-SWITCH-IO-00-R (5300\_10)

Item no.	Item name	Part
5400_01	IRM6-S-HD-00-R	Sensor unit
5500_10	IRM6-I-SWITCH-IO-00-R	Interface unit

### 8.4 IRMA6-SENSOR-HD-00-SWITCH-00-R (5300\_11)

Item no.	Item name	Part
5400_01	IRM6-S-HD-00-R	Sensor unit
5500_11	IRM6-I-SWITCH-00-R	Interface unit